

MOLUFAMA

Rua Roldão Galdino da Rosa, 80
88740-000 - Armazem/SC
Fone - 48-3645-0016 - 47-99921-2728

MANUAL INSTALAÇÃO KIT PORTA CORRER



1) FERRAMENTAS NECESSÁRIAS



Serra meia esquadria

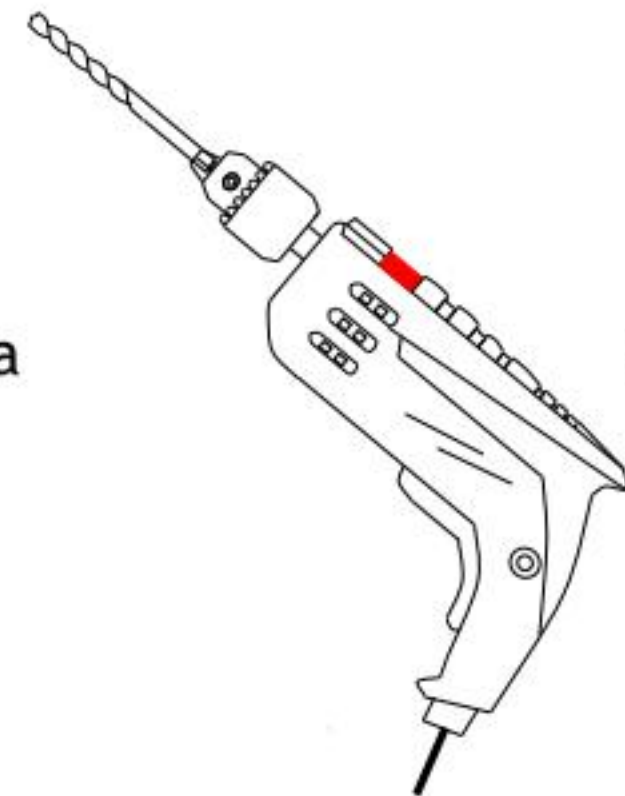

Furadeira/parafusadeira



martelo



Martelo borracha



estilete



borrifador



trena



punção



nível



prumo

1) Montar os batentes

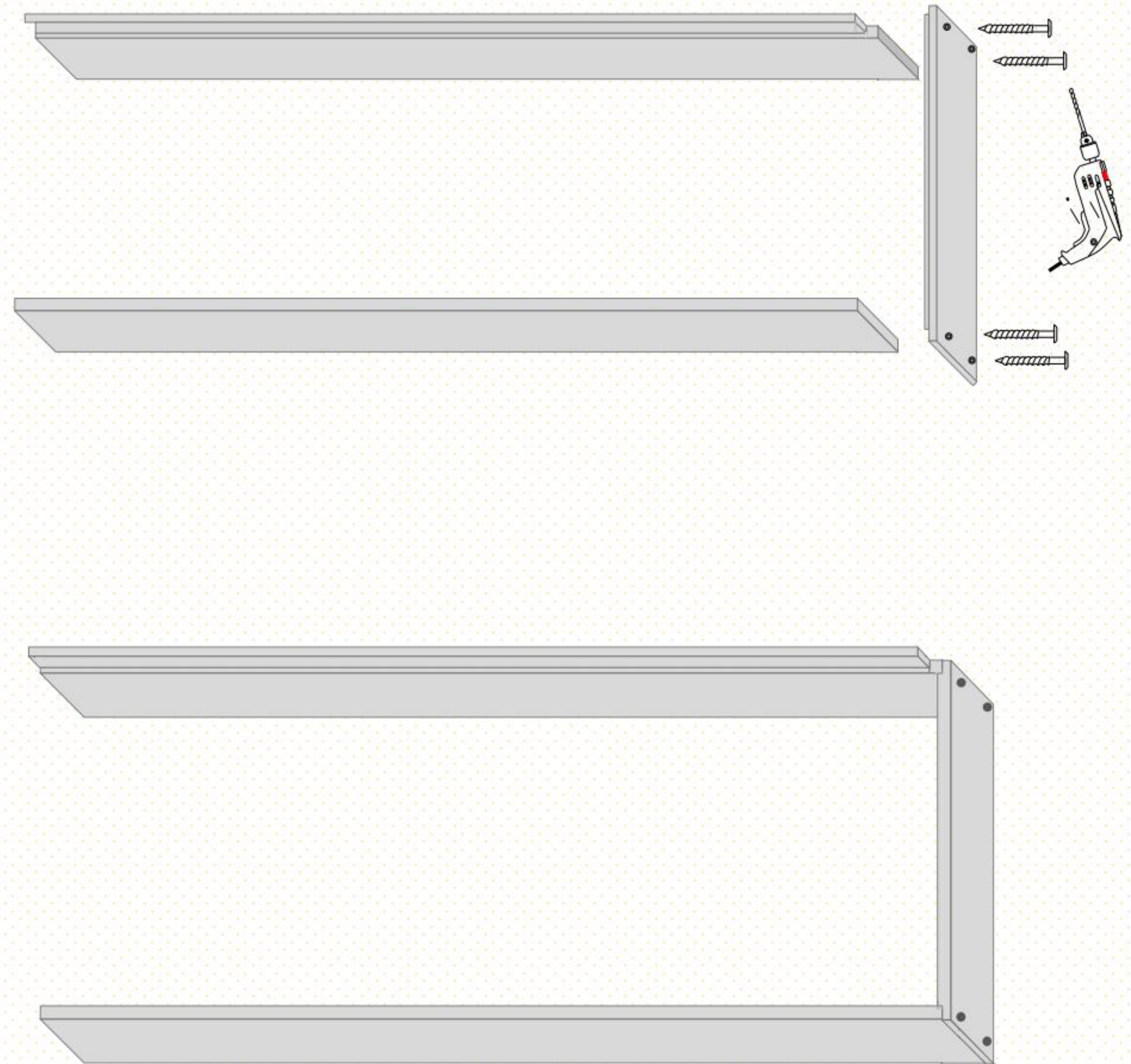

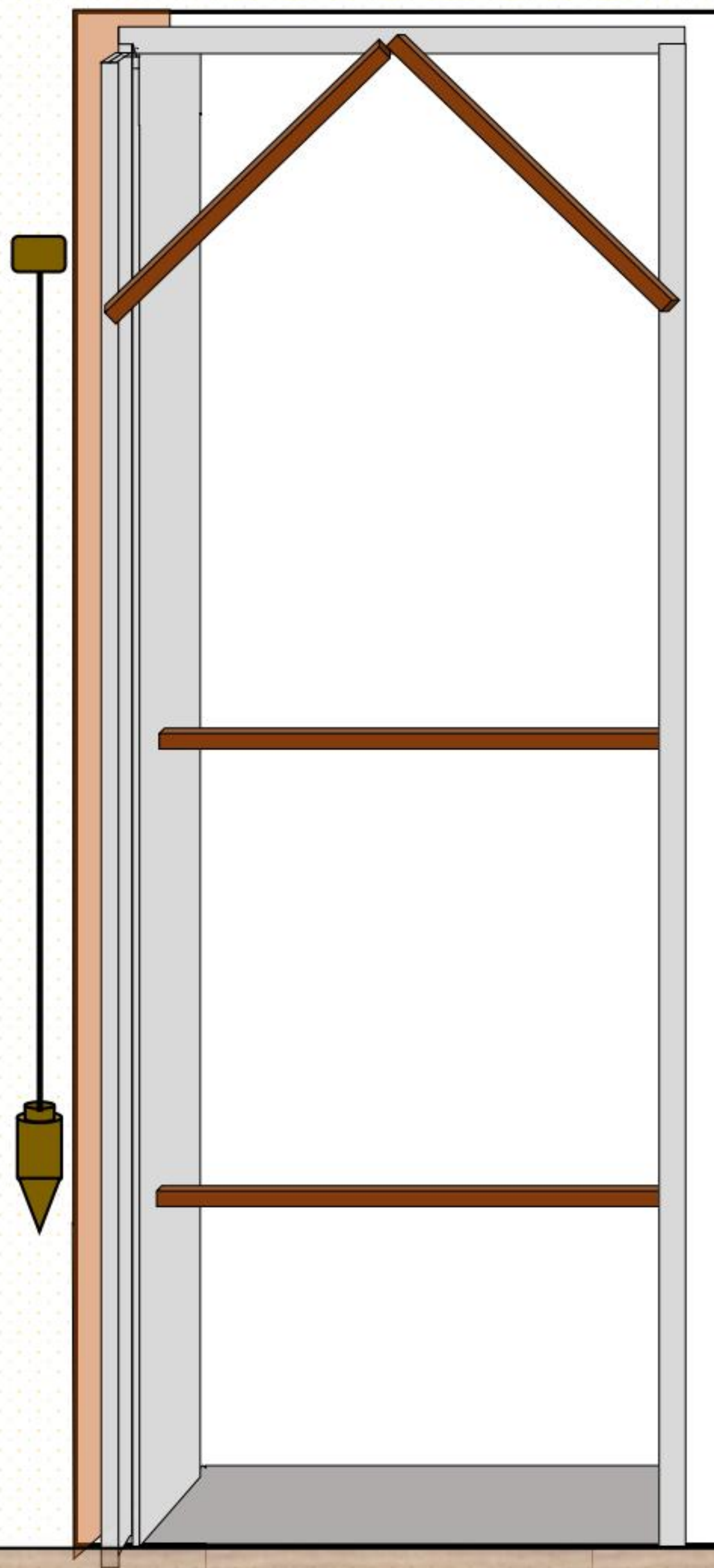

- 1) Encaixe o kit no vão da alvenaria.
- 2) Prumar, nivelar e deixar no esquadro, fixando provisoriamente com cunhas.

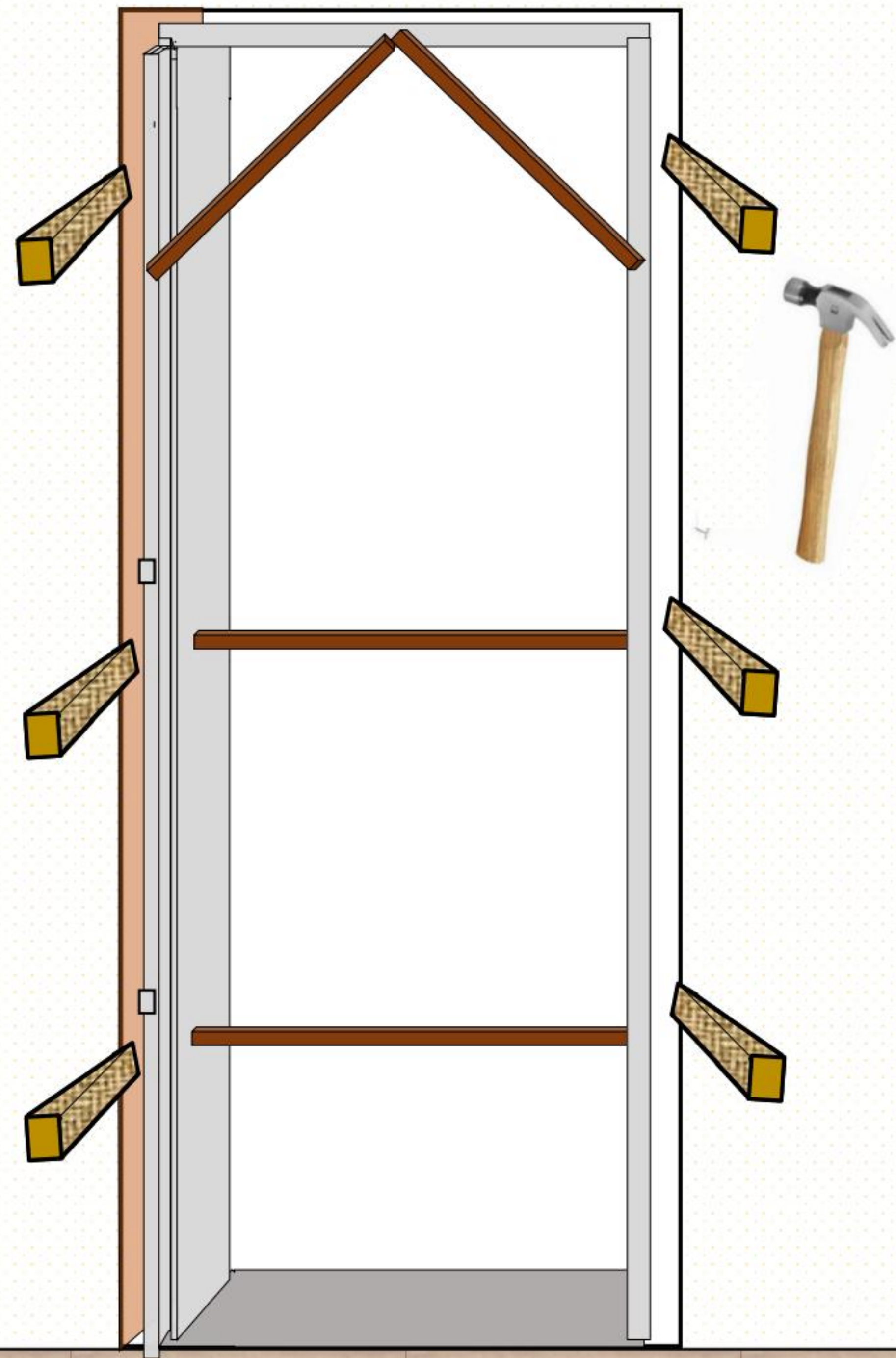

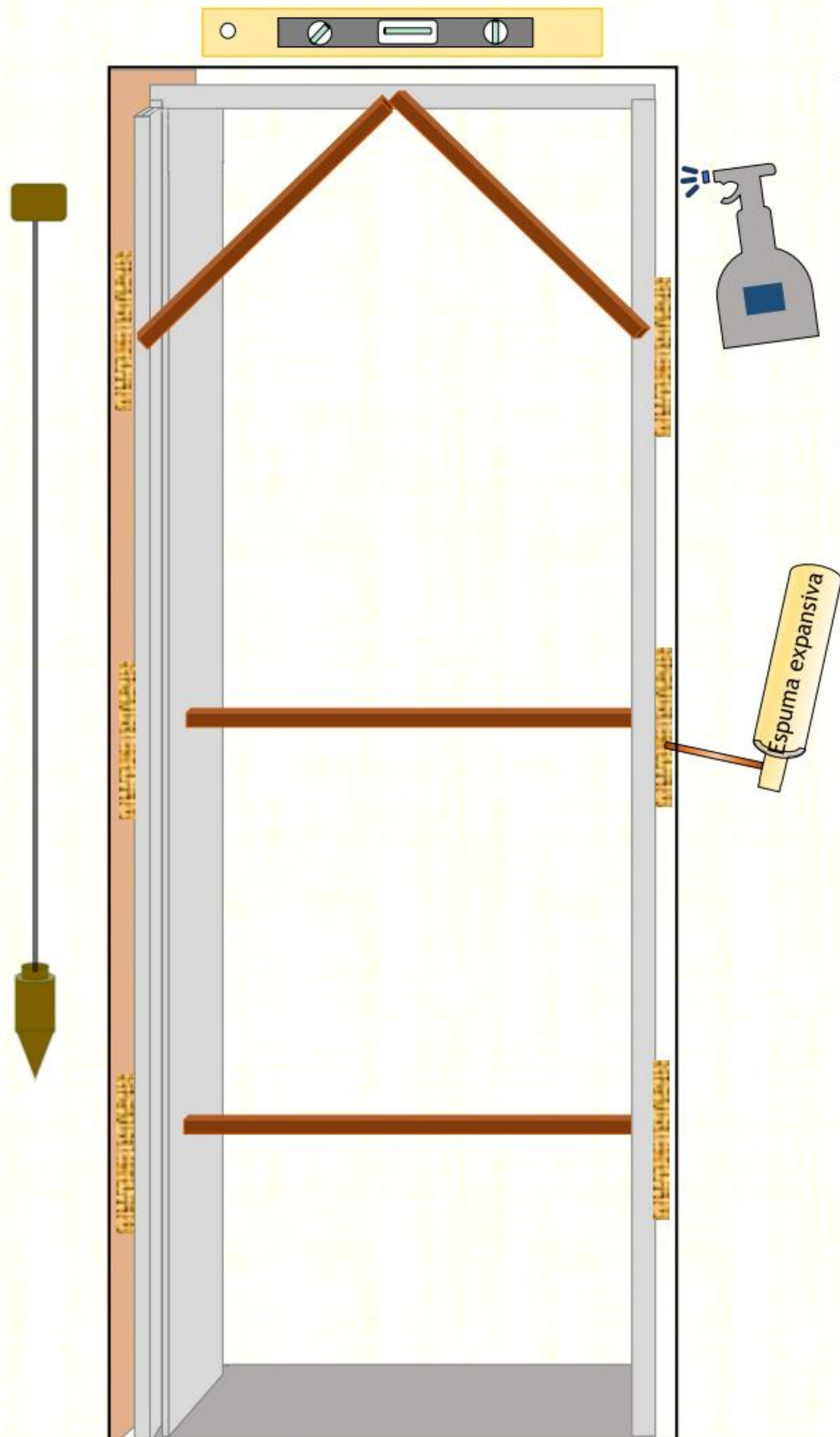

- 1) Umedecer alvenaria nos pontos de aplicação da espuma expansiva.
- 2) Aplicar espuma expansiva.
- 3) Após cura da espuma retirar as cunhas e cortar o excesso com estilete.

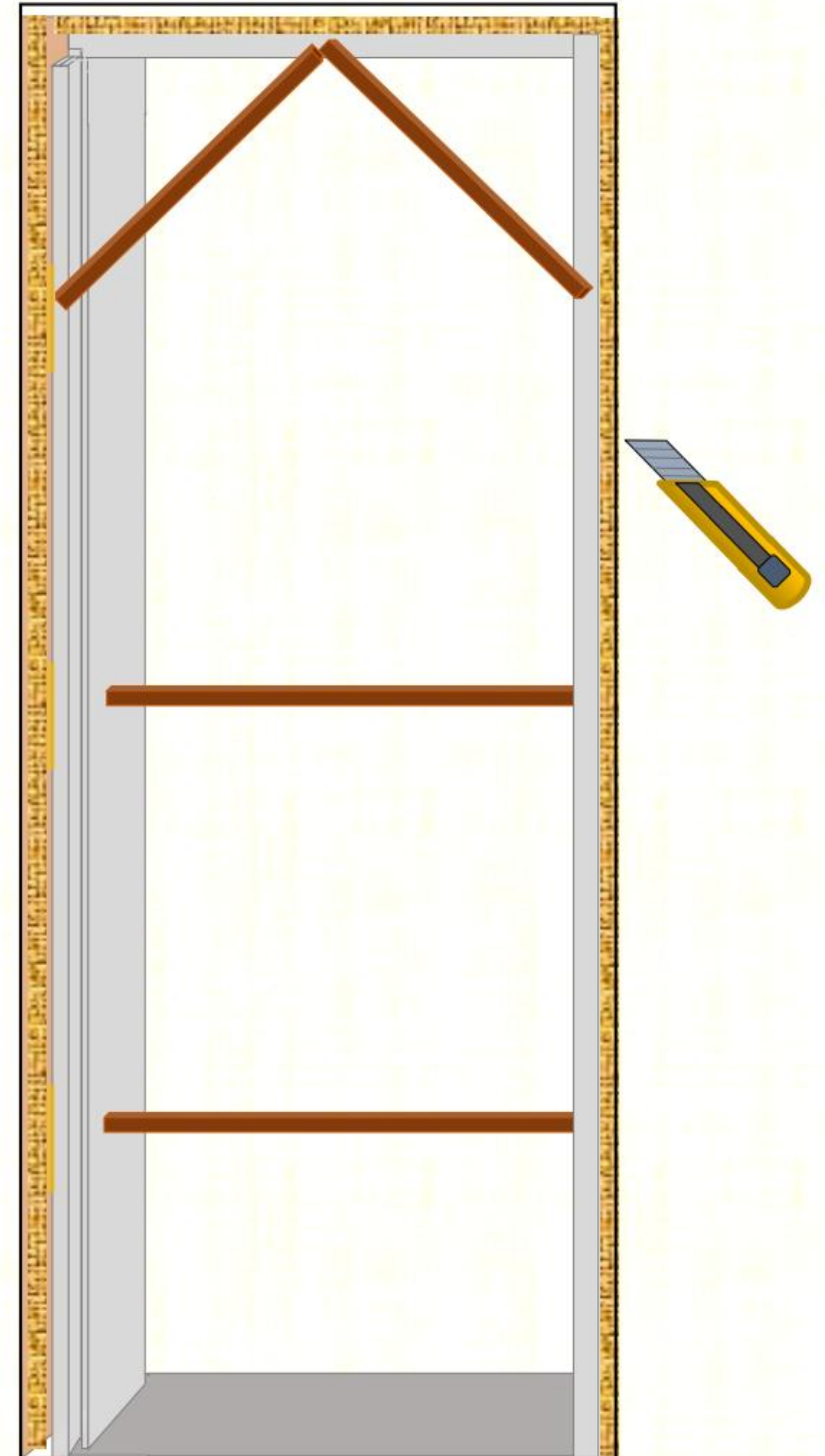

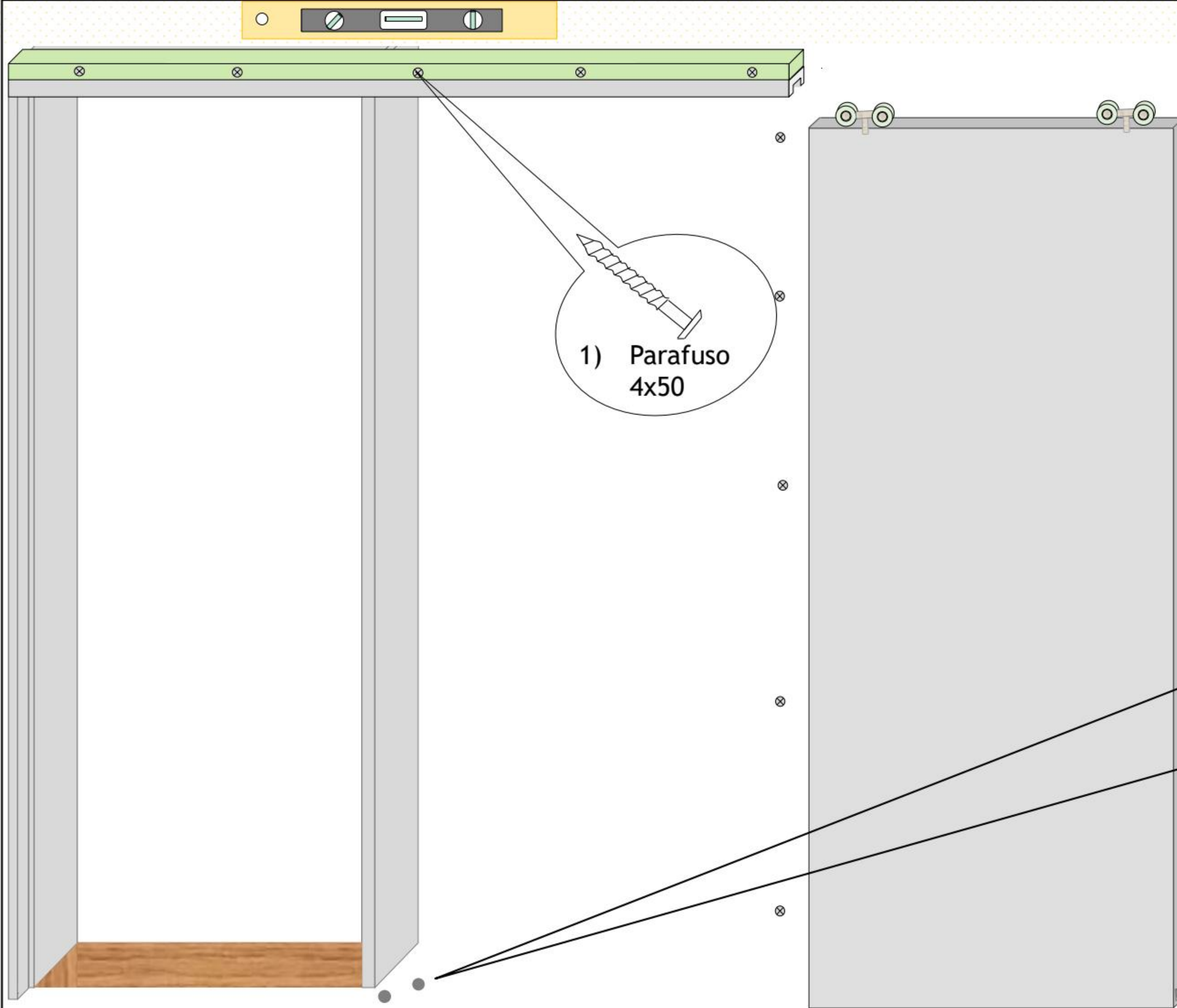

1) Parafuso
4x50

- 1) Fixar travessa superior com o trilho
- 2) Fixar guia da porta na parte inferior, piso para que a porta deslize nivelada

1) Bucha 6 mm
2) Parafuso 4x40
mm

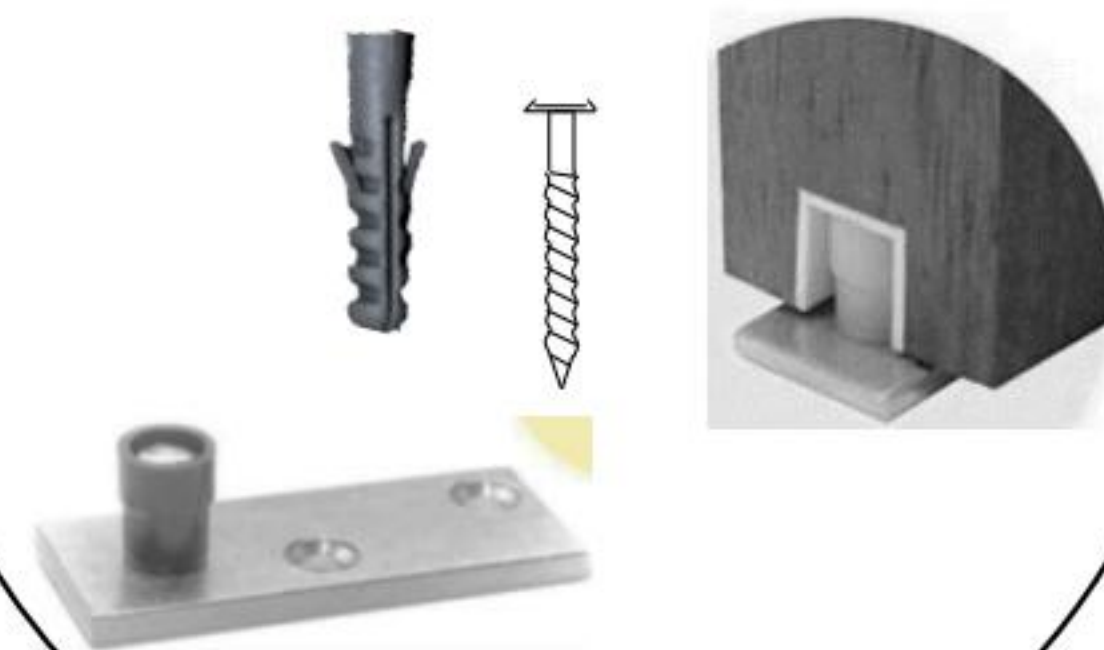

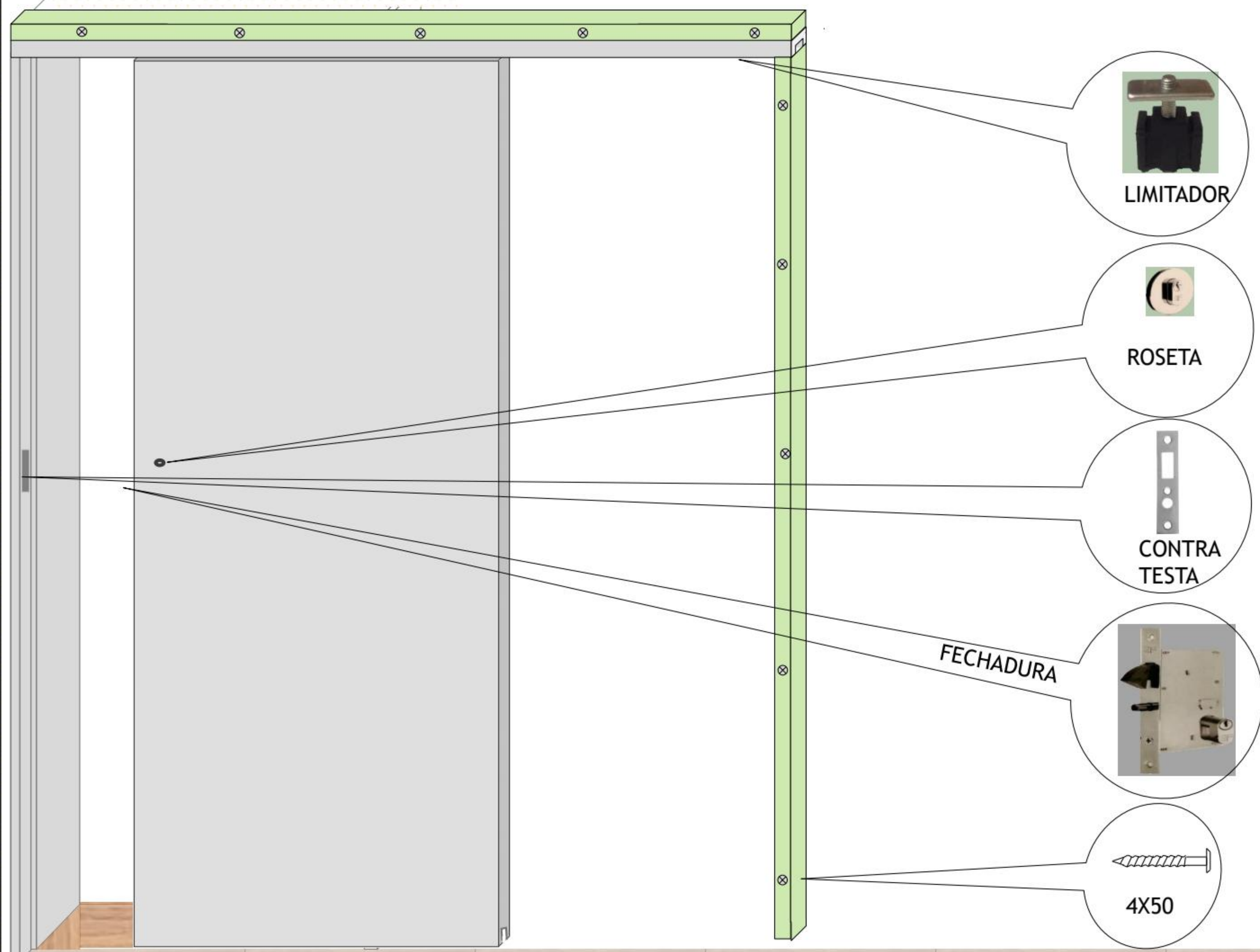

LIMITADOR



ROSETA



CONTRA TESTA



FECHADURA

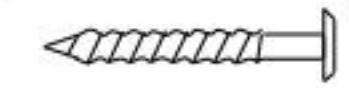

4X50

- 1) Fixar travessa vertical com os parafusos 4x50
- 2) Colocar limitador da porta
- 3) Instalar fechadura, contra testa e roseta

FIXAÇÃO DAS GUARNIÇÕES E ARREMATES

- 1) Ajustar as guarnições e arremates nas medidas adequadas.
- 2) As guarnições podendo ser em 45° ou 90° conforme a preferencia.

1) Fixar os arremates 50X03 mm vertical fazendo acabamento entre a guarnição e a parede.(vão atrás onde corre a folha da porta)

1) Fixar os arremates 50X03 mm horizontal na parte de baixo. (rodapé)



Guarnição

Arremate 50x03 mm

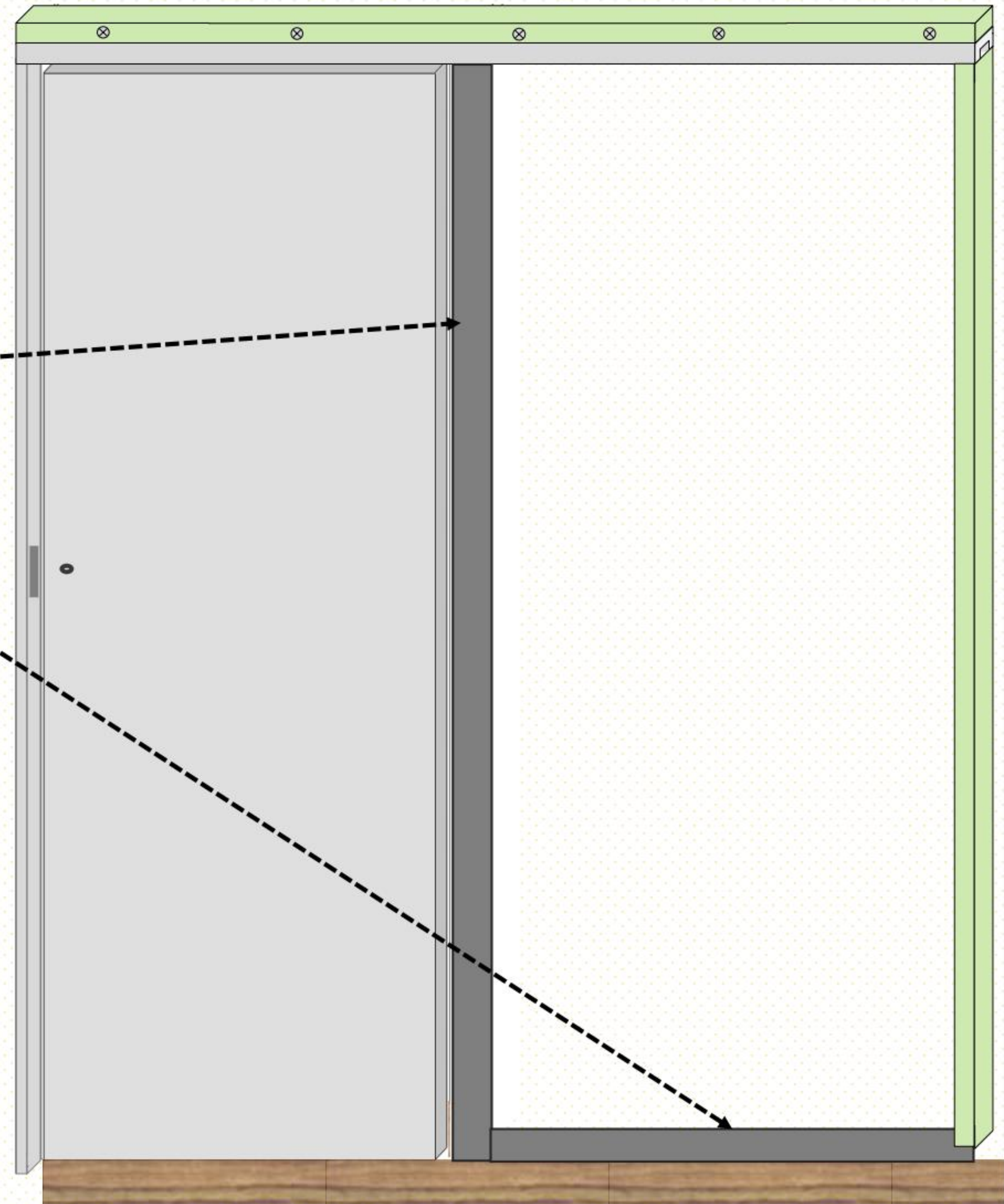

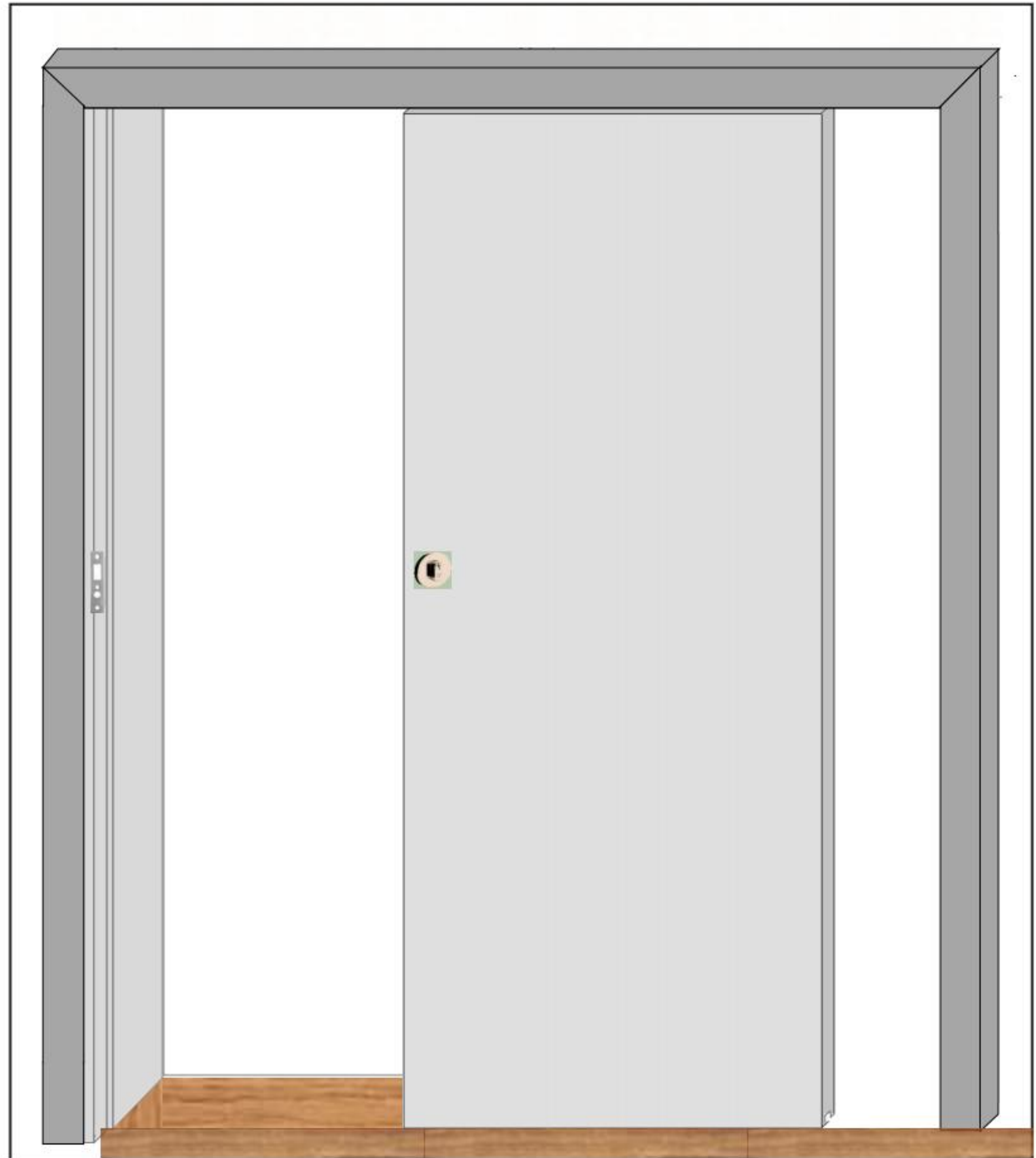
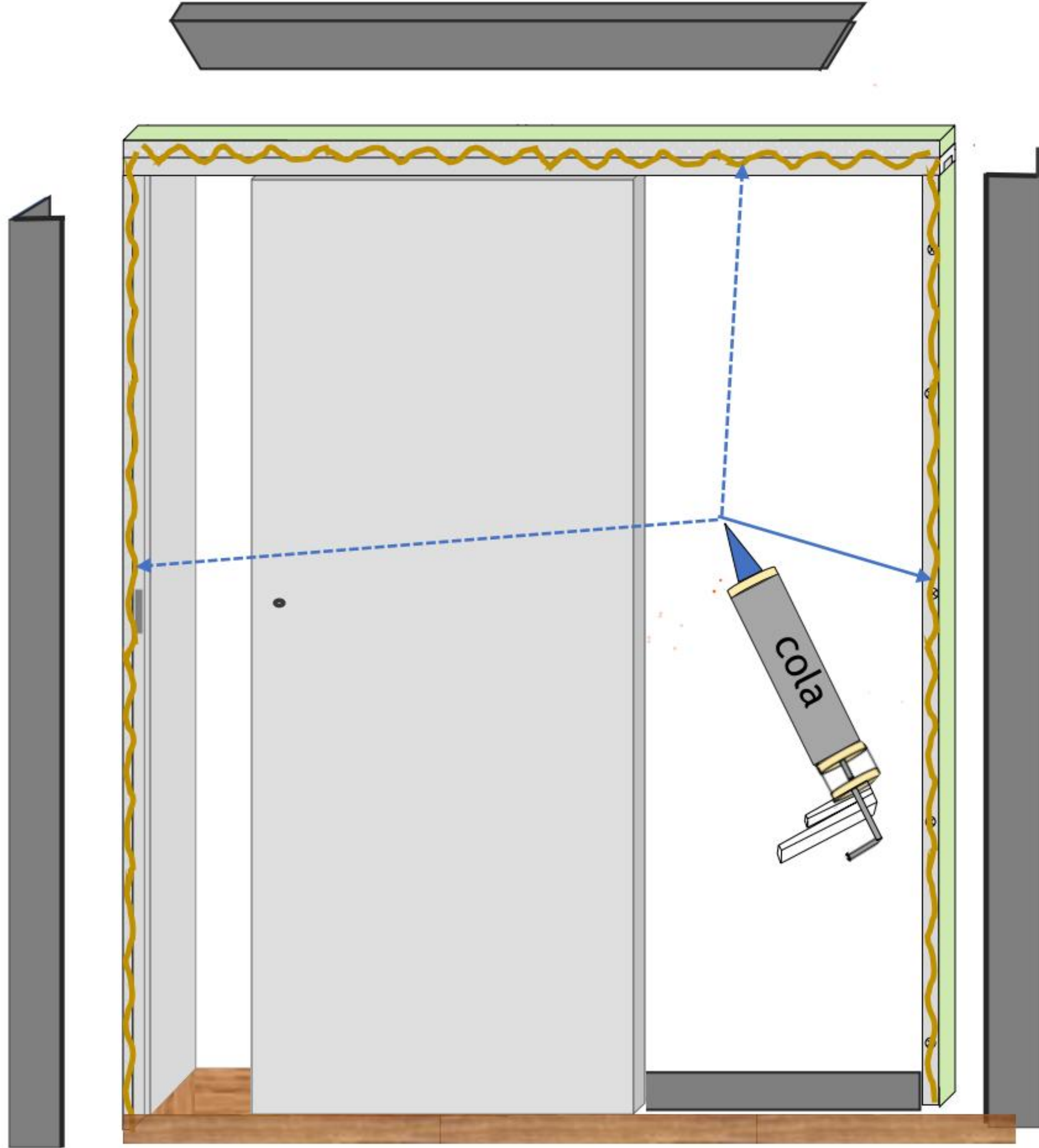

1) Aplicar cola, fixar elas nas laterais e parte superior do quadro nas posições conforme imagem.

COLOCAÇÃO DAS GUARNIÇÕES LADO INTERNO

- 1) Ajustar as guarnições na medidas necessárias, podendo ser 45° ou em 90°
- 2) Aplicar cola, fixar elas canais adequados.

